

ID	Description	Date	By	Appr.
A				

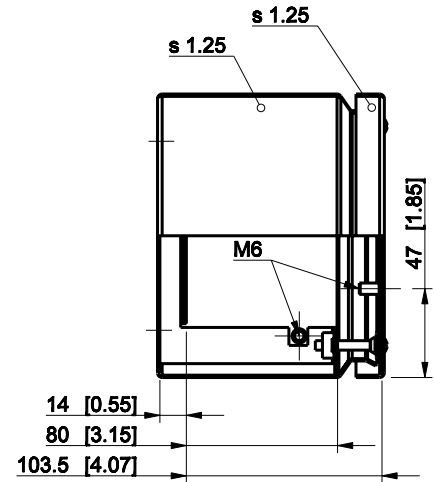
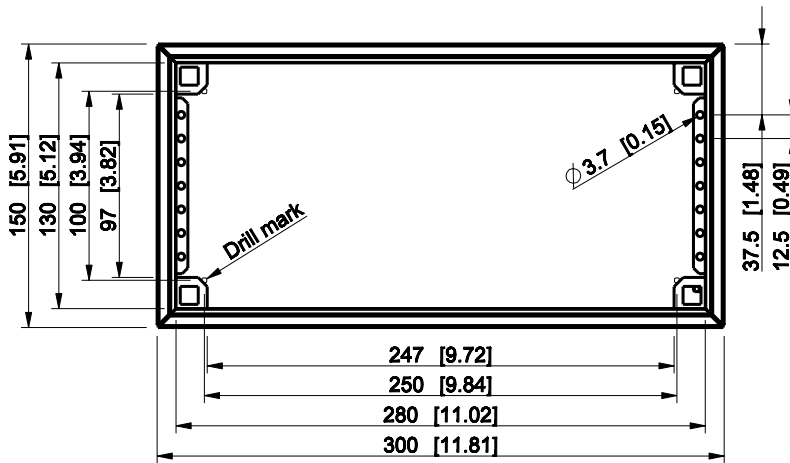
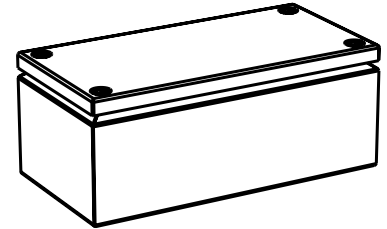
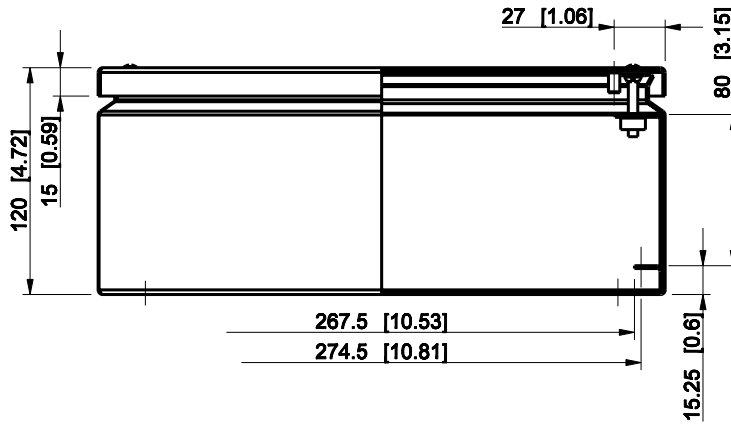

Dimensions in mm [inches]

Material: <b>Stainless steel, AISI 304</b>	Color:
--	--------

Supplier:	Tool No:	Weight [kg]: <b>2.26</b>	Volume:
-----------	----------	--------------------------	---------

**ENSTO**  
ENSTO CONTROL OY



**FSUP301512**

Scale	Date	05.12.08
1:4	By	VLe
-	Checked	
-	Ctrl	

Replaces:	
Replaced:	
Drw No:	A
Ref:	Cubo F
Code:	FSUP301512
Sheet No:	

model FSUP301512\_PART

drawing FSUP\_DRAWING