

MATERIAL: PU (SELF-ADHESIVE/WITH 3M GLUE) ; COLOR: CLEAR

RF-6002

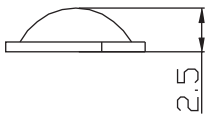

RF-6009

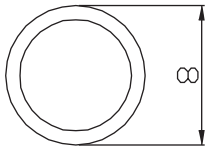
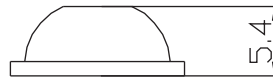
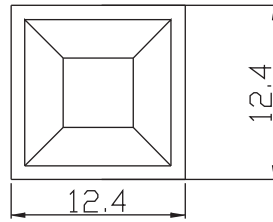

RF-6012

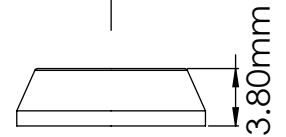
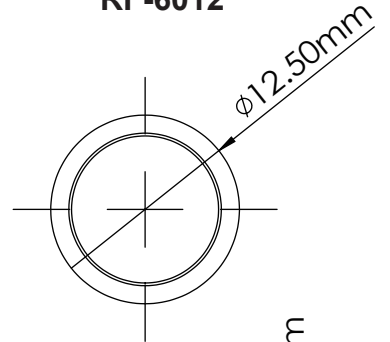

RF-6004

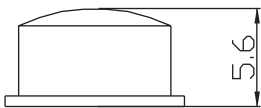
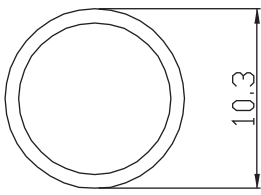

RF-6010

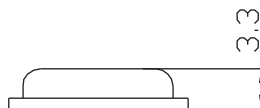
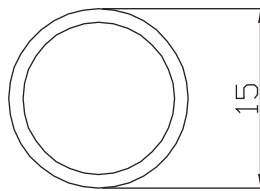

RF-6016

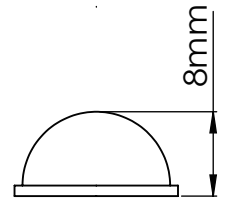
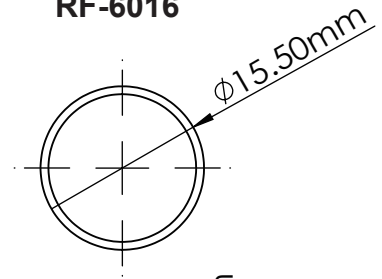

RF-6006

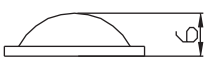
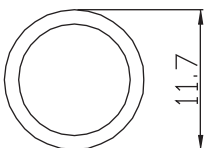

RF-6011

