

9001 Series

DIN41612 R Type Male

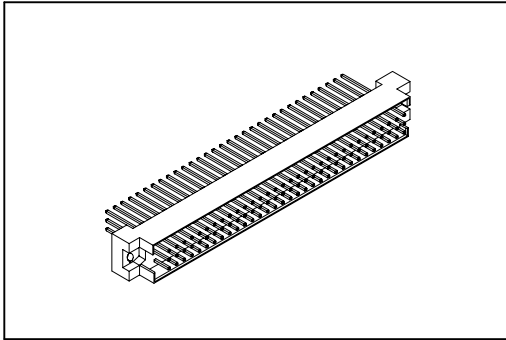

Material:

Housing: 30% Glass Filled PBT UL94V-0.
Contacts: Brass.

Electrical Characteristics:

Current Rating: 2 A.
Dielectric Withstanding Voltage: AC 1000V.
Insulator Resistance: 1000MΩ min.
Contact Resistance: 30mΩ max.
Operating Temperature: -55°C ~+105°C .

Features:

- * UL, cUL listing.
- * Mates with Female 3Row
9001-1296,1264, C Type.
9001-1496,1464, R Type.
9001-1264, IDC Type.

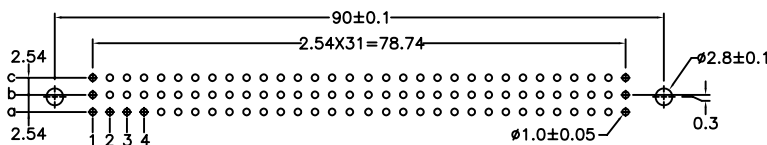
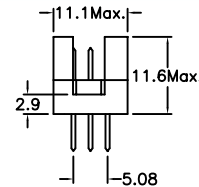
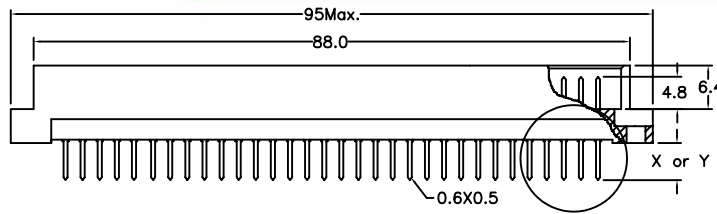
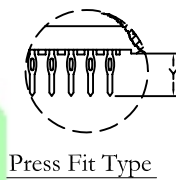
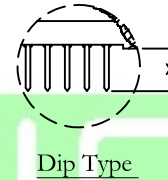
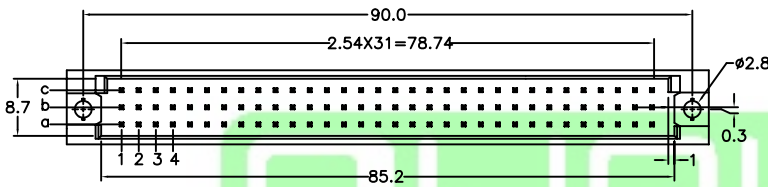

P.C. Board Layout

| Length | 1 | 2 | W1 | W2 |
|--------|----------|--------------------|-----------------|----|
| X | 4.0 | 2.5 | 13 | 17 |
| Y | 4.6 | 6.3 | 13 | 17 |
| Pitch | Position | Rows with Contacts | Contact Arrange | |
| 2.54mm | 96 | a b c | | |
| | 64 | a - c | | |
| | 32 | a - - | | |
| 5.08mm | 48 | a b c | | |
| | 32 | a - c | | |
| | 16 | a - - | | |

Ordering information

| | | | | | | | | |
|----------------|------------------------|-----------|----------|--|---------------------------------------|---|----------------------------|--|
| 9001- <u>1</u> | <u>3</u> | <u>96</u> | <u>1</u> | <u>C</u> | <u>00</u> | <u>P</u> | <u>L1</u> | <u>A</u> |
| Series | 1: 2.54mm 2: 5.08mm | 3: Male | Position | 1: Dip Length 2: Dip Length W1: Dip Length W2: Dip Length | C: Dip Tin Contact Gold G: Gold | 00: G/F 10: 10μ" 15: 15μ" 30: 30μ" | Blank: Dip P: Press Fit | Blank: W/O Lock L1: With Lock See Page CA04 |

*Standard Gold Flash.